



WHAT'S IN THE BOX

Your Gear Loft™ Includes: (1) Gear Loft and (1) Carry Bag

SHELTER SET UP

NOTE: This accessory is intended to be installed in the corner of your E-Z UP® shelter, Camping Cube™ or Screen Cube™.

1. Completely set up your E-Z UP® shelter in the area that you intend to shade according to the owner's manual instructions, leaving at its lowest height setting.
2. Locate the right FXT Clip on the Gear Loft next to the E-Z UP woven label. (Fig. A) Attach FXT Clip to your shelter truss system, remembering to attach to the right of the Nut & Bolt Assembly.

NOTE: Step 3 will be different dependent on shelter*

3. Locate the center FXT Clip on the Gear Loft.

Cross Truss Shelters

- 1) Attach FXT Clip to the FXT Loop on the top truss. (Fig. B)

Open Truss Shelters

- 1) Attach FXT Clip to the Top Center Truss. (Fig. C)

4. Locate the left FXT Clip on the Gear Loft next to the E-Z UP woven label. (Fig. D) Attach FXT Clip to your shelter truss system, remembering to attach to the left of the nut and bolt assembly.
5. Tighten or loosen Adjustment Straps to achieve best fitment. (Fig. E)
6. Raise your shelter to your preferred height.

TAKE DOWN

1. Repeat steps in reverse of assembly.

CARE & MAINTENANCE

- Use a mild soap (not detergent) and plenty of water for cleaning. Let the E-Z UP® Gear Loft™ dry completely before closing or storing to avoid mildew.
- Store in the Carry Bag Provided.

Instructions for Gear Loft™

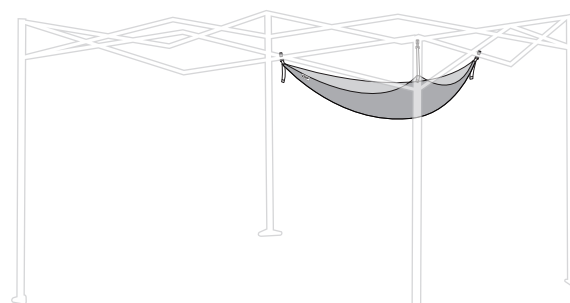

Fig. A

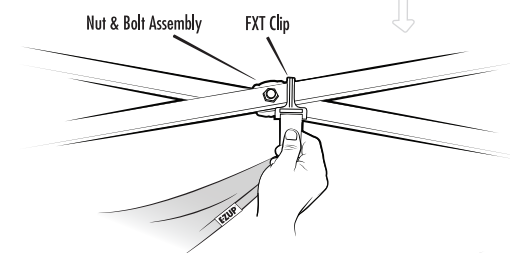

Fig. B

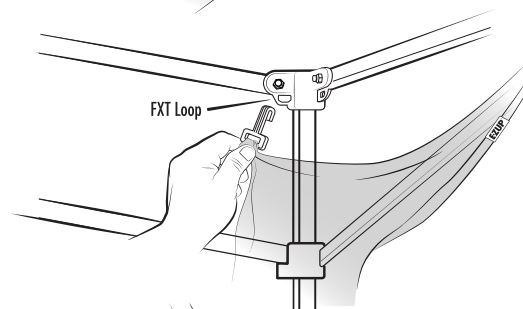

Fig. C

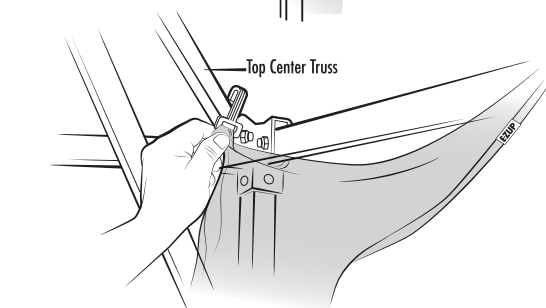

Fig. D

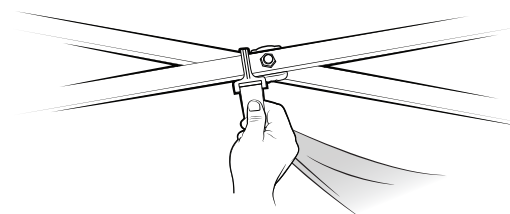
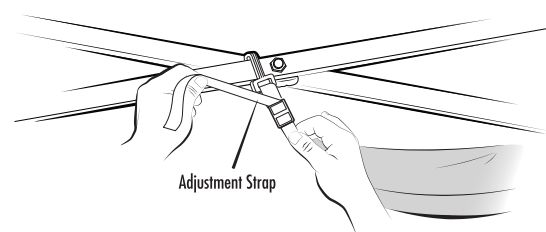

Fig. E



© Copyright 2017 International E-Z UP, Inc. USA. All rights reserved.

INTERNATIONAL E-Z UP, INC.
1900 Second St. Norco, California 92860

800-45-SHADE

The #1 Instant Shelter® Brand in the World

ezup.com



WHAT'S IN THE BOX

Your Gear Loft™ Includes: (1) Gear Loft and (1) Carry Bag

CAMPING CUBE™ SCREEN CUBE™ SET UP

NOTE: This accessory is intended to be installed in the corner of your E-Z UP® shelter, Camping Cube™ or Screen Cube™.

1. Completely set up your E-Z UP® Instant Shelter® in the area that you intend to shade according to the owner's manual instructions, leaving at its lowest height setting.
2. Locate the right FXT Clip on the Gear Loft next to the E-Z UP woven label. (Fig. A) Attach FXT Clip to your right O Ring Hanger* as illustrated.
3. Locate the center FXT Clip on the Gear Loft. Attach FXT Clip to the center O Ring Hanger*. (Fig. B)
4. Locate the left FXT Clip on the Gear Loft. Attach FXT Clip to your left O Ring Hanger* as illustrated. (Fig. C)
5. Tighten or loosen Adjustment Straps to achieve best fitment. (Fig. D)
6. Raise your shelter to your preferred height.

*** Important Information:**

- Interior O Ring Hanger(s) not to exceed 5lb. hanging weight.

TAKE DOWN

1. Repeat steps in reverse of assembly.

CARE & MAINTENANCE

- Use a mild soap (not detergent) and plenty of water for cleaning. Let the E-Z UP® Gear Loft™ dry completely before closing or storing to avoid mildew.
- Store in the Carry Bag Provided.

Instructions for Gear Loft™

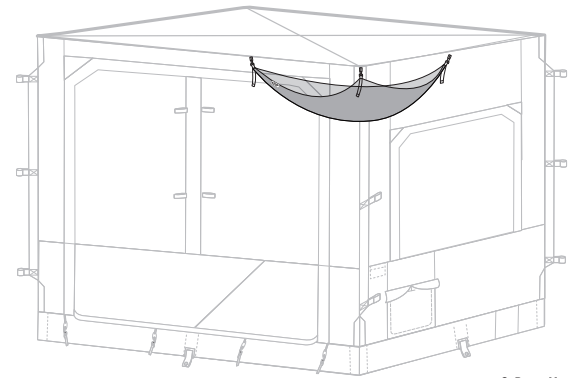

Fig. A

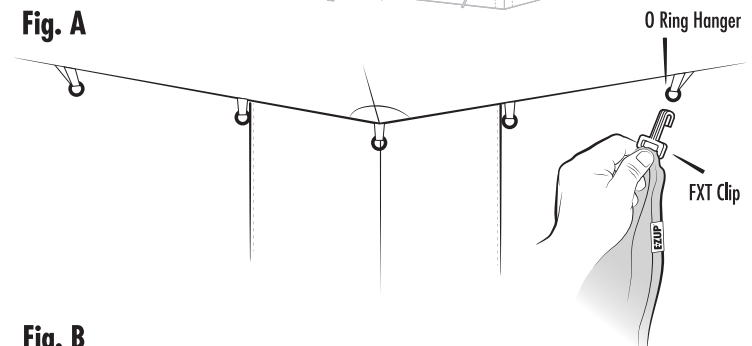

Fig. B

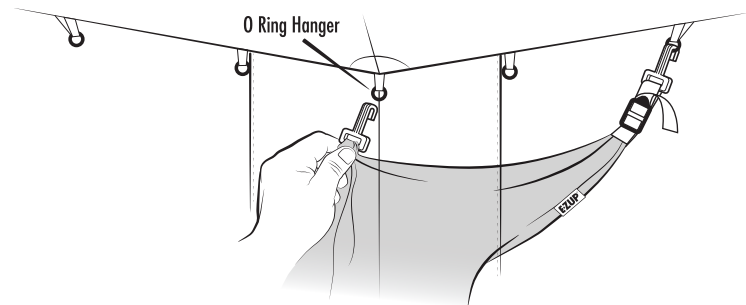

Fig. C

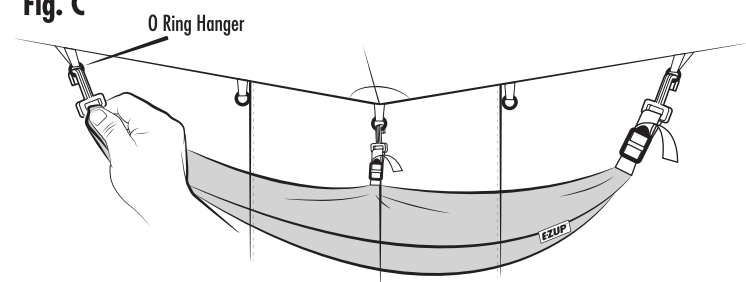
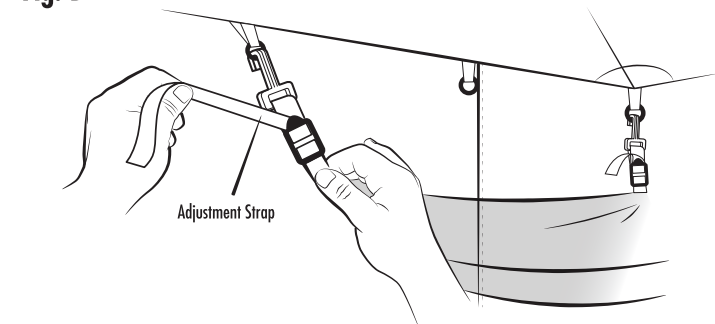

Fig. D



© Copyright 2017 International E-Z UP, Inc. USA. All rights reserved.

INTERNATIONAL E-Z UP, INC.
1900 Second St. Norco, California 92860

800-45-SHADE

The #1 Instant Shelter® Brand in the World

ezup.com